

SYN 169 s
SUL 189 s

Ⓓ **Bedienungsanleitung**
Schaltuhr

Ⓔ **Operating instructions**
Time Switch

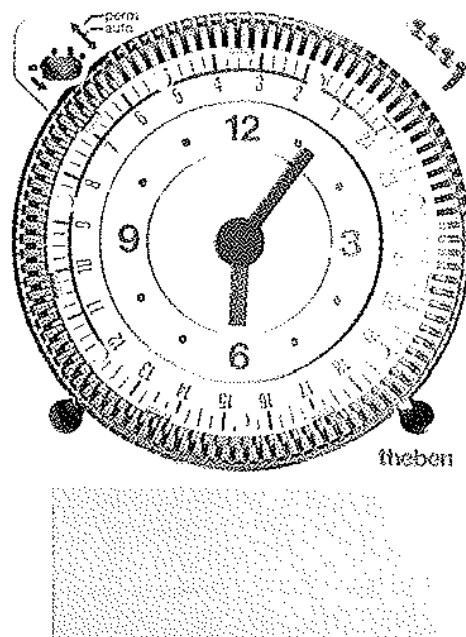

Ⓔ MOUNTING INSTRUCTIONS

Safety information: Electrical devices should only be connected and mounted by an electrical specialist. Manipulations and modifications on the switch will result in loss of warranty. The national specifications and applicable safety regulations must be observed.

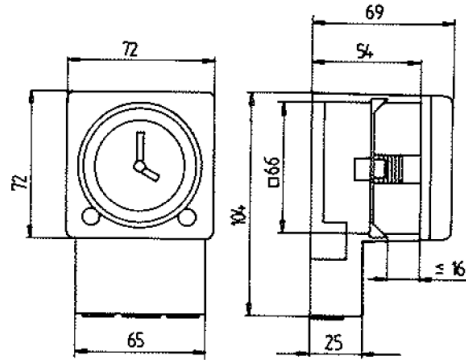
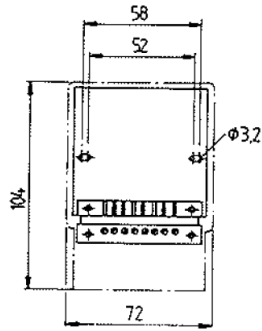
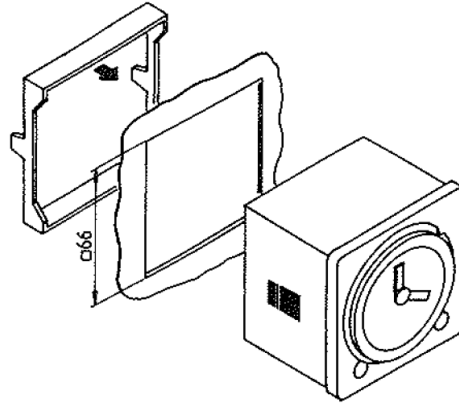
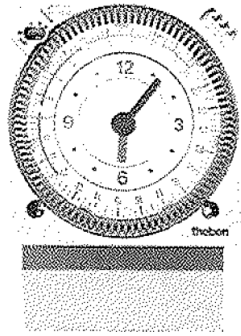

SYN 169 s

230 V / 50 Hz

SUL 189 s

Quartz * R = 3d (72h)

230 V / 45 – 60 Hz

* The quartz movement starts automatically after a few minutes by an applied voltage. The full power reserve is built up after about 3 days.

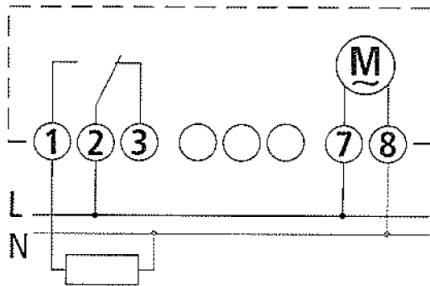

Theben AG

Hohenbergstraße 32

72401 Haigerloch

Deutschland

Fon +49 74 74 / 6 92-0

Fax +49 74 74 / 6 92-150

Service

Fon +49 74 74 / 6 92-369

Fax +49 74 74 / 6 92-207

hotline@theben.de

Addresses, telephone numbers etc. at

www.theben.de

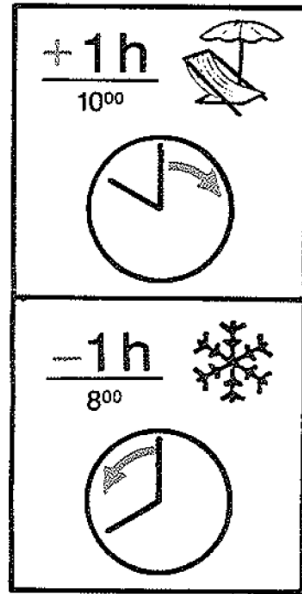
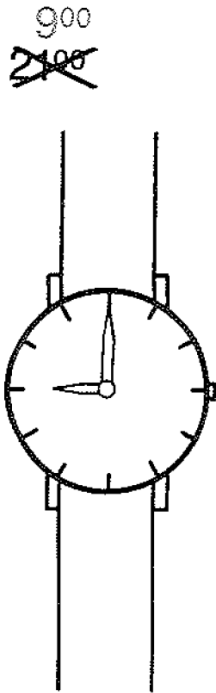
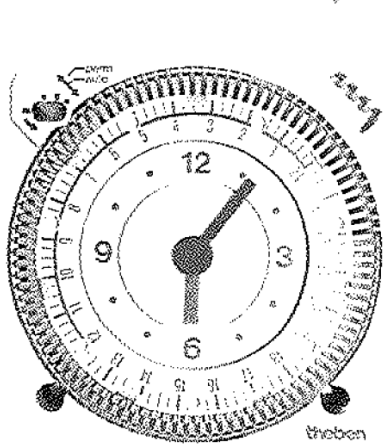

24 h-Programm

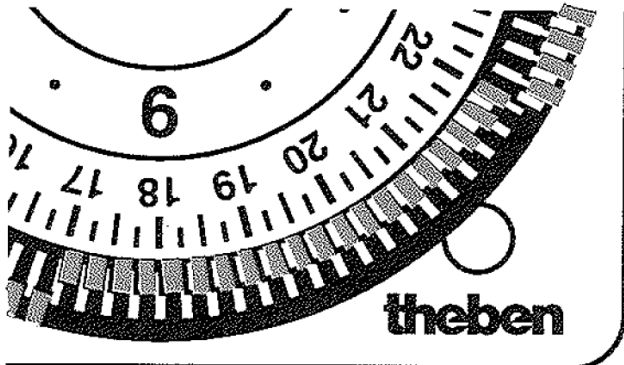
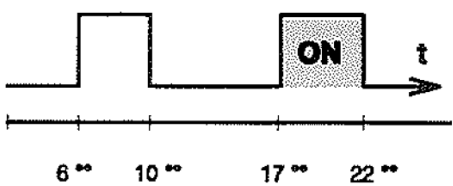
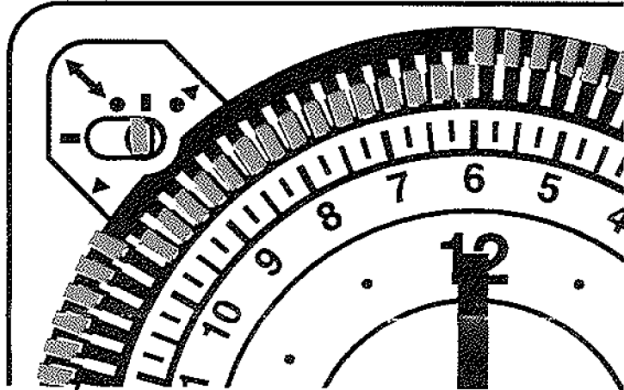
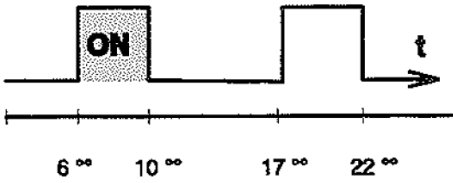

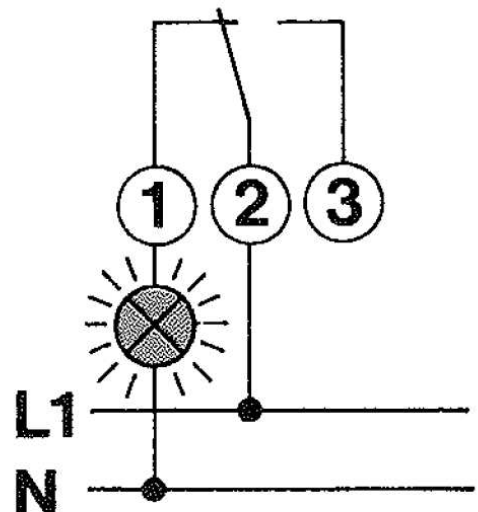
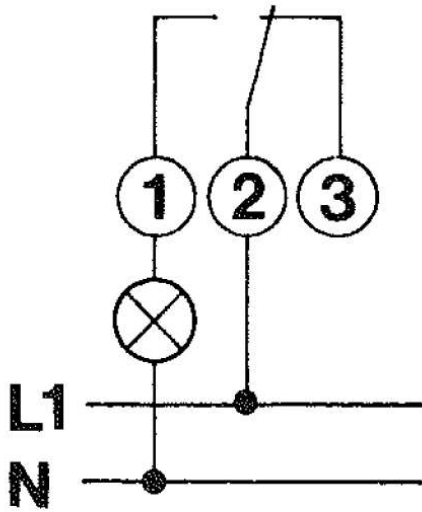
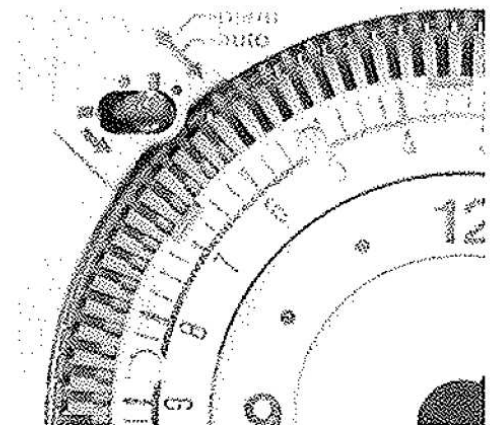
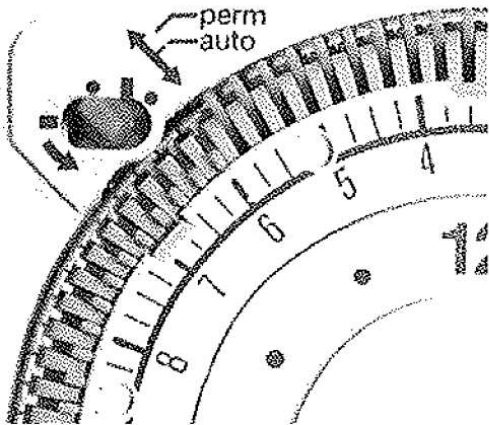
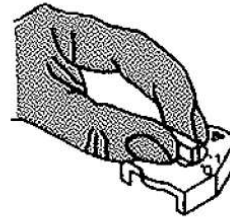

Programm auto



Ⓞ

Manual Control ON/OFF (Override Control)

Turn the control axis  in direction of arrow by one notch; ON=  or OFF =  The manual control is automatically annulled by the following counteracting command of the automatic program sequence.

Programm permanent ON / OFF

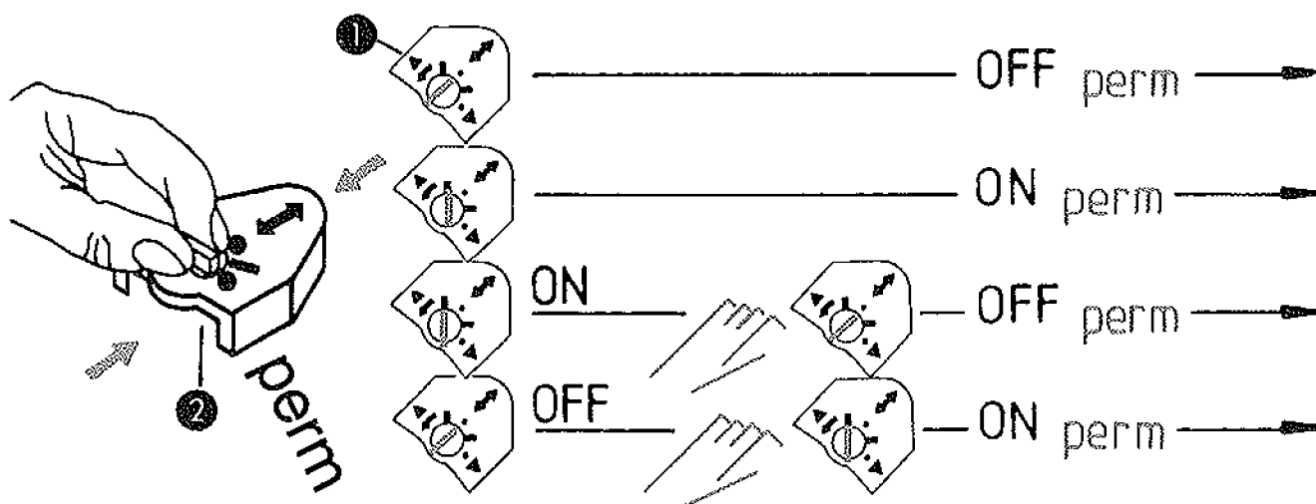

GB Permanent Control ON/OFF

Set the hand lever ② to »perm« = permanent control; turning the control axis ① in direction of arrow, the required permanent control ON or OFF can now be adjusted. Turning the hand lever to »Auto« = Automatic Control, the permanent control is terminated. The actual switch position is maintained until the next counteracting command of the automatic program sequence is triggered. An immediate correction can be carried out by means of the manual control (override control).

EMV / CEM / EMC / ETY

- GB** The time switches are in accordance with the European directives 73/23/EEC. (Low-Voltage Directive) and 89/336/EEC (EMC-Directive). If the time switches are used together with other devices in an installation, take care that the complete installation does not cause a radio interference.